

Ñ

CASTAÑOSOFÁS

Tarifa técnica

CASTAÑOSOFÁS una pasión que nace para llegar a todo el mundo. Supervisamos cada paso en nuestro proceso de producción para obtener la máxima calidad.

CASTAÑOSOFÁS

04



Luxor

06



Cies

08



Lider

18



Loira

20



New Califa

22



Betty

24



Tabarca

10



Ons

12



Nilo

16



Dali

26



Cloe

28



Berlin

30



Capri



MODELO

Luxor

VANGUARDIA Y ESTILO

TARIFA POR PUNTOS

MÓDULOS	S/0	S/1	S/2	S/3	S/4	S/5	T/C	Mts.
Mod 75. 1 Pl. 75cm. S/ Br.	222	230	242	262	283	303	193	4,5
Mod 90. 1 Pl. 90 cm. S/ Br.	242	251	264	285	307	329	211	4,7
Mod 105. 1 Pl. 105 cm. S/Br.	265	276	289	314	338	362	231	5,2
Mod 120. 1 Pl. 120 cm. S/Br.	299	311	326	353	379	406	262	5,8



MÓDULOS	S/0	S/1	S/2	S/3	S/4	S/5	T/C	Mts.
Mod 100. 1 Pl. 75 cm. C/ Br.	272	283	298	325	351	377	235	5,6
Mod 115. 1 Pl. 90 cm. C/ Br.	300	313	329	358	387	416	259	6,2
Mod 130. 1 Pl. 105 cm. C/Br.	323	337	355	388	420	452	277	6,9
Mod 145. 1 Pl. 120 cm. C/Br.	351	366	385	420	454	490	301	7,4

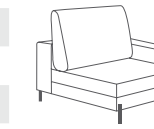

MÓDULOS	S/0	S/1	S/2	S/3	S/4	S/5	T/C	Mts.
Mod 150. 2 Pl. 75 cm. S/ Br.	356	374	397	438	479	520	298	9
Mod 180. 2 Pl. 90 cm. S/ Br.	409	429	456	502	549	596	342	10,5
Mod 210. 2 Pl. 105 cm. S/Br.	443	464	491	540	588	636	374	11,5



MÓDULOS	S/0	S/1	S/2	S/3	S/4	S/5	T/C	Mts.
Mod 175. 2 Pl. 75 cm. C/ Br.	412	432	459	505	552	598	346	10
Mod 205. 2 Pl. 90 cm. C/ Br.	460	483	513	567	620	673	384	11,5
Mod 235. 2 Pl. 105 cm. C/Br.	513	537	568	624	679	735	433	12

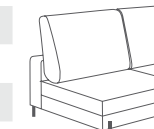

CHAISELONGUE	S/0	S/1	S/2	S/3	S/4	S/5	T/C	Mts.
Chaise. 100x170cm (1as.75)	381	393	410	439	468	497	340	6,5
Chaise. 115x170cm (1as.90)	410	423	443	474	506	539	364	7
Chaise. 130x170cm (1as.105)	452	467	488	524	560	596	400	8

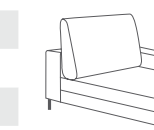

CHAISE. TERMINAL	S/0	S/1	S/2	S/3	S/4	S/5	T/C	Mts.
Chaise. terminal 113x215cm	527	557	583	634	683	732	464	10,5

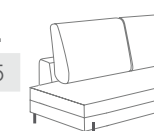

TERMINAL ABIERTO	S/0	S/1	S/2	S/3	S/4	S/5	T/C	Mts.
Terminal con oreja 120	346	356	370	393	417	441	312	5
Terminal con oreja 135	368	378	392	416	440	464	333	5,5
Terminal con oreja 150	392	404	420	448	476	503	353	6
Terminal con oreja 165	421	433	452	482	513	543	378	6,7



RINCÓN	S/0	S/1	S/2	S/3	S/4	S/5	T/C	Mts.
Rincón 113X113cm	336	350	368	399	430	462	292	7

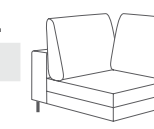

POUFFS	S/0	S/1	S/2	S/3	S/4	S/5	T/C	Mts.
Pouff 75x75	139	144	151	163	175	187	122	2,5
Pouff 90x90	157	163	170	183	196	209	138	2,7
Pouff 105x105	178	184	192	207	221	236	157	3
Pouff 120x120	200	207	217	234	251	268	176	3,5

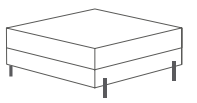

SOFÁS 2 BRAZOS (UNA PIEZA)	S/0	S/1	S/2	S/3	S/4	S/5	T/C	Mts.
Sofá 200 (2 asientos 75)	467	490	520	573	626	680	391	11,5
Sofá 230 (2 asientos 90)	518	545	579	640	699	760	433	13
Sofá 260 (2 asientos 105)	571	598	635	698	762	825	480	14,2

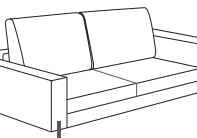

*Incluye dos cuadrantes

SOFÁS 2 PIEZAS PARTIDO	S/0	S/1	S/2	S/3	S/4	S/5	T/C	Mts.
Sofá 260. 2mod.130 (2 asientos 105)	646	674	710	776	840	904	554	14,2
Sofá 290. 2mod. 145 (2 asientos 120)	702	732	770	840	908	980	602	15

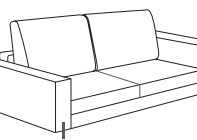

*Incluye dos cuadrantes

SILLONES	S/0	S/1	S/2	S/3	S/4	S/5	T/C	Mts.
Sillón 125cm (asiento 75)	332	346	364	398	429	461	287	7,2
Sillón 140cm (asiento 90)	368	382	404	441	477	513	317	8,5



*Incluye un cuadrante

COMPOSICIONES	S/0	S/1	S/2	S/3	S/4	S/5	T/C	Mts.
Sofá maxi 290 (Mod. 145C/B + MOD. 145C/B)	702	732	770	840	908	980	602	15
Chaise. 275 (Mod. 175C/B + Chaise. 100)	793	825	869	944	1020	1095	686	15,5
Chaise. 320 (Mod. 205C/B + Chaise. 115)	870	906	956	1041	1126	1212	748	18,5
Chaise.Terminal 318 X 215 (Mod. 205 C/B + terminal 113 X 215)	987	1040	1096	1201	1303	1405	848	22
Rincón + Terminal 318 X 248 (Mod 205 C/B + Rincón 113 +terminal abierto 135)	1164	1211	1273	1382	1490	1599	1009	24
Rincón + Terminal 348 X 263 (Mod 235 C/B + Rincón 113 +terminal abierto 150)	1241	1291	1356	1471	1585	1700	1078	25

EXTRAS	S/0	S/1	S/2	S/3	S/4	S/5	T/C	Mts.
Cuadrante 55x55	14	17	20	23	28	31	10	0.60/u
Riñonera 80x32	18	21	24	27	30	33	15	0.90/u
Cubrebrazo	12	14	16	20	24	28	9	1.20/u
Reposacabezas	18	20	22	24	27	30	15	0.60/u
Metraje	12	15	19	22	25	28		

*Tarifa de precio en puntos

*Tarifa de precios con brazo de 25cm

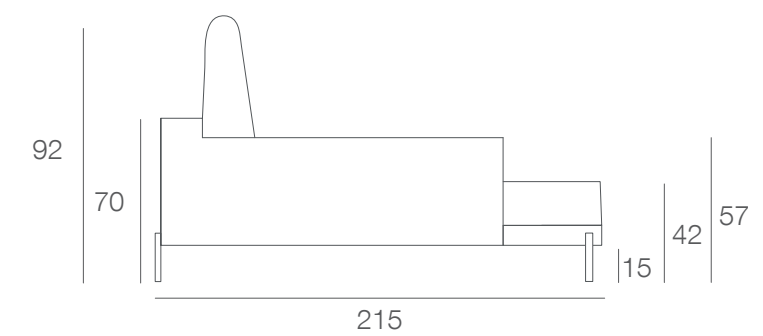
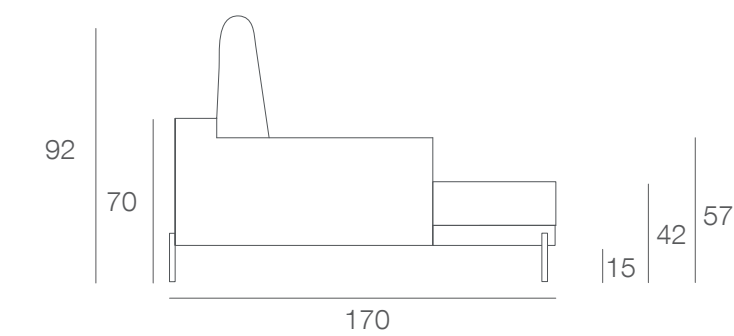
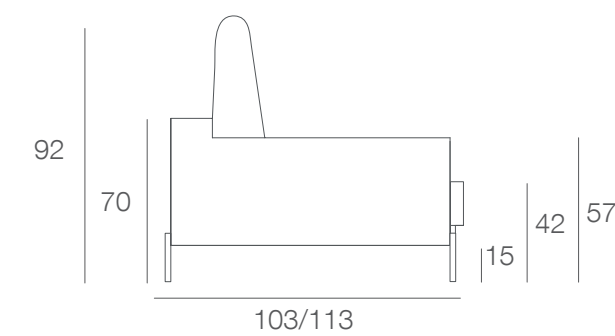

MODELO *Cies*



SOFISTICADO
|
EXTRAÍBLE DE CARRO

TARIFA POR PUNTOS

MÓDULOS	S/0	S/1	S/2	S/3	S/4	S/5	T/CL	Mts.
Mod. 1Pl. 66cm. S/Br.(As66)	242	250	260	270	285	302	229	3,4
Mod. 1Pl. 80cm. S/Br. (As80)	264	272	285	298	316	336	246	4,1
Mod. 1Pl. 86cm. S/Br. (As86)	283	291	303	317	335	357	265	4,2
Mod. 1Pl. 96cm. S/Br. (As96)	293	302	315	329	348	369	275	4,3
Mod. 1Pl. 106cm.S/Br. (As106)	309	319	333	348	368	391	290	4,6
Mod. 1Pl. 116 cm.S/Br.(As116)	328	338	353	369	390	415	307	5
MÓDULOS	S/0	S/1	S/2	S/3	S/4	S/5	T/CL	Mts.
Mod. 1Pl. 82cm. C/Br.(As66)	283	295	310	327	347	367	270	5,3
Mod. 1Pl. 96cm. C/Br. (As80)	302	315	331	350	371	393	286	5,8
Mod. 1Pl. 102cm. C/Br. (As86)	318	329	347	368	391	413	304	6
Mod. 1Pl. 112cm. C/Br. (As96)	330	345	364	384	408	431	315	6,2
Mod. 1Pl. 122cm.C/Br. (As106)	350	365	384	406	431	456	332	6,5
Mod. 1Pl. 132 cm.C/Br.(As116)	365	380	401	423	450	476	346	6,8
MÓDULOS	S/0	S/1	S/2	S/3	S/4	S/5	T/CL	Mts.
Mod. 2Pl. 132 cm. S/Br. (2As.66cm)	406	420	440	465	494	522	373	6,8
Mod. 2 Pl. 160 cm. S/Br. (2As.80cm)	446	461	485	513	546	579	407	7,6
Mod. 2 Pl. 172 cm. S/Br. (2As.86cm)	474	490	515	545	580	616	438	8,1
MÓDULOS	S/0	S/1	S/2	S/3	S/4	S/5	T/CL	Mts.
Mod. 2 Pl. 148 cm. C/Br. (2As.66cm)	442	458	481	510	542	575	410	8,2
Mod. 2 Pl. 176 cm. C/Br. (2As.80cm)	480	498	525	556	593	630	443	9,1
Mod. 2 Pl. 188 cm. C/Br. (2As.86cm)	512	532	561	594	633	684	473	9,7
CHAISELONGUE	S/0	S/1	S/2	S/3	S/4	S/5	T/CL	Mts.
Chaiselongue 86 x 170 (1Asiento.70cm)	360	375	390	415	440	466	340	5,8
Chaiselongue 96 x 170 (1Asiento.80cm)	375	391	407	434	461	489	360	6,1
Chaiselongue 106 x 170 (1Asiento.90cm)	400	415	432	461	490	519	380	6,6
EXTRAS	S/0	S/1	S/2	S/3	S/4	S/5	T/CL	Mts.
Cuadrantes 45x45 platabanda combi	14	17	20	23	28	31	10	0.60u.
Cuadrantes 45x45	10	13	16	20	24	28	7	0.60u.
Riñonera 55x35	9	12	15	19	23	27	6	0.50u.
Cubrebrazo (ud.)	12	14	16	20	24	28	8	0.80u.
Metraje	12	15	19	22	26	30		

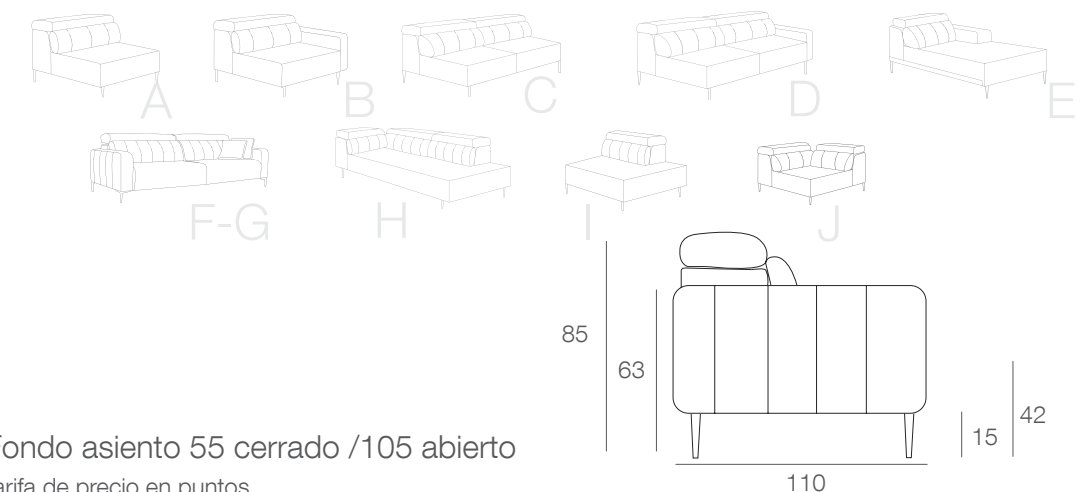

Fondo asiento 55 cerrado /105 abierto
*Tarifa de precio en puntos

SOFÁS 2 BR.(1pieza)	S/0	S/1	S/2	S/3	S/4	S/5	T/CL	Mts.
Sofá 164 (2 as. 66)	490	511	538	570	608	646	450	9,5
Sofá 192 (2 as. 80)	530	553	583	619	661	704	486	10,4
Sofá 204 (2 as. 86)	580	605	636	675	719	764	535	11,2
SOFÁS 2 BR.(partidos)	S/0	S/1	S/2	S/3	S/4	S/5	T/CL	Mts.
Sofá 164 (2 as. 66)	566	590	620	654	694	734	540	10,6
Sofá 192 (2 as. 80)	604	630	662	700	742	786	572	11,6
Sofá 204 (2 as. 86)	636	658	694	736	782	826	608	12
Sofá 224 (2 as. 96)	660	690	728	768	816	862	630	12,4
Sofá 244 (2 as. 106)	700	730	768	812	862	912	664	13
Sofá 264 (2 as. 116)	730	760	802	846	900	952	692	13,6
TERMINAL RINCÓN	S/0	S/1	S/2	S/3	S/4	S/5	T/CL	Mts.
Chaise terminal 100x200	495	515	540	578	630	672	455	9
Chaise terminal 110x200	510	530	555	601	646	692	470	9,5
TERMINAL ABIERTO	S/0	S/1	S/2	S/3	S/4	S/5	T/CL	Mts.
Terminal abierto 105 (1respaldo 70cm)	341	355	371	400	428	456	310	6
Terminal abierto 115 (1respaldo 80cm)	350	365	382	414	444	475	320	6,5
Terminal abierto 125 (1respaldo 90cm)	362	378	397	430	463	496	330	7
RINCÓN	S/0	S/1	S/2	S/3	S/4	S/5	T/CL	Mts.
Rincón 110x110	375	391	412	447	483	518	338	7,5
POUFF (CAJÓN TAPIZADO)	S/0	S/1	S/2	S/3	S/4	S/5	T/CL	Mts.
Pouff 80 x 80	155	165	175	188	199	210	145	3
Pouff 90 x 60	165	175	185	198	209	221	155	3,5
COMPOSICIONES	S/0	S/1	S/2	S/3	S/4	S/5	T/CL	Mts.
Comp. Sofá 3 asientos 230 cm. (mod. 148 c/b + mod. 82 c/b)	725	753	791	837	889	942	680	13,5
Comp. Sofá 3 asientos 272 cm. (mod. 176 c/b + mod. 96 c/b)	782	813	856	906	964	1023	729	14,9
Comp. Sofá 3 asientos 290 cm. (mod. 188 c/b + mod. 102 c/b)	830	861	908	962	1024	1097	777	15,7
Comp. chaiselongue 272 X 170 cm. (mod. 176 c/b + chaise 96 c/b)	855	889	932	990	1054	1119	803	15,2
Comp. chaiselongue 294 X 170 cm. (mod. 188 c/b + chaise 106 c/b)	912	947	993	1055	1123	1203	853	16,3
Comp. Term. Rincón 286 X 200 cm. (mod. 176 c/b + terminal rincón 110 c/b)	990	1028	1080	1157	1239	1322	913	18,6
Comp. Term. Rincón 298 X 200 cm. (mod. 188 c/b + terminal rincón 110)	1022	1062	1116	1195	1279	1376	943	19,2
Comp. Rincón + Terminal abierto 286 X 225 cm. (mod. 176 c/b + rincón 110x110 + terminal abierto 115cm)	1205	1254	1319	1417	1520	1623	1101	23,1
Comp. Rincón + Terminal abierto 298 X 235 cm. (mod. 188 c/b + rincón 110x110 + terminal abierto 125cm)	1249	1301	1370	1471	1579	1698	1141	24,2

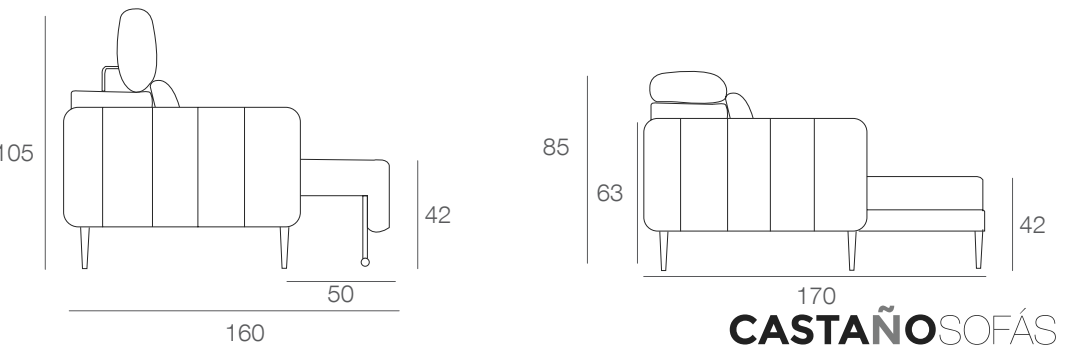



MODELO

Lider

ARMONÍA Y FRESCURA

TARIFA POR PUNTOS

	MÓDULOS	S/0	S/1	S/2	S/3	S/4	S/5	
A	Mod. 1 Pl. 60 cm. S/ Br.	190	205	225	250	265	280	
	Mod. 1 Pl. 70 cm. S/ Br.	190	205	225	250	265	280	
	Mod. 1 Pl. 80 cm. S/ Br.	200	215	235	260	276	291	
	Mod. 1 Pl. 90 cm. S/ Br. *Incluye 1 riñonera	215	230	250	275	292	308	
B	Mod. 1 Pl. 83 cm. C/ Br.	215	230	250	275	292	308	
	Mod. 1 Pl. 93 cm. C/ Br.	215	230	250	275	292	308	
	Mod. 1 Pl. 103 cm. C/ Br.	225	240	260	283	300	317	
	Mod. 1 Pl. 113 cm. C/ Br. *Incluye 1 riñonera + 1 cuadrante	240	255	275	300	318	336	
C	Mod. 2 Pl. 120 cm. S/ Br.	330	355	380	405	429	454	
	Mod. 2 Pl. 140 cm. S/ Br.	330	355	380	405	429	454	
	Mod. 2 Pl. 160 cm. S/ Br.	340	365	390	420	445	470	
	Mod. 2 Pl. 180 cm. S/ Br. *Incluye 2 riñoneras *Opcional 2 asientos o colchoneta	355	380	405	435	461	487	
D	Mod. 2 Pl. 143 cm. C/ Br.	350	375	400	425	451	476	
	Mod. 2 Pl. 163 cm. C/ Br.	350	375	400	425	451	476	
	Mod. 2 Pl. 183 cm. C/ Br.	360	385	410	440	466	493	
	Mod. 2 Pl. 203 cm. C/ Br. *Incluye 2 riñoneras + 1 cuadrante *Opcional 2 asientos o colchoneta	375	400	425	455	482	510	
E	TERMINALES SIN OREJA	S/0	S/1	S/2	S/3	S/4	S/5	
	Terminal con brazo 103x180	375	400	425	455	482	510	
F	Terminal con brazo 113x180	390	415	440	470	498	526	
	*Incluye 1 riñonera + 1 cuadrante							
G	TERMINALES CON OREJA	S/0	S/1	S/2	S/3	S/4	S/5	
	Terminal con brazo 103x215	425	450	475	505	535	566	
H	Terminal con brazo 113x215	440	465	490	520	551	582	
	*Incluye 1 riñonera + 1 cuadrante							
I	RINCÓN	S/0	S/1	S/2	S/3	S/4	S/5	
	Rincón 103 X 103	260	275	295	320	340	358	
	*Incluye 2 riñoneras							
	POUFFS	S/0	S/1	S/2	S/3	S/4	S/5	
Pouff 70x70	135	150	170	190	201	213		
Pouff 80x80	135	150	170	190	201	213		
Pouff 90x90	160	170	185	205	217	230		
J	SOFÁ 2 BRAZOS	S/0	S/1	S/2	S/3	S/4	S/5	
	Sofá 166 cm. (2 asientos 60)	415	440	465	490	519	549	
	Sofá 186 cm. (2 asientos 70)	415	440	465	490	519	549	
	Sofá 206 cm. (2 asientos 80)	425	450	475	505	535	566	
	Sofá 226 cm. (2 asientos 90) *Incluye 2 riñoneras + 2 cuadrantes *Opcional 2 asientos o colchoneta	445	470	495	525	556	588	
	MODULO 1 PL. + OREJA	S/0	S/1	S/2	S/3	S/4	S/5	
Mod. 95 con oreja	265	280	300	325	345	364		
Mod. 105 con oreja	265	280	300	325	345	364		
Mod. 115 con oreja	275	290	310	335	355	375		
Mod. 125 con oreja *Incluye 1 riñonera (1 respaldo)	290	305	325	350	371	392		
K	SOFA 2 PL. + OREJA	S/0	S/1	S/2	S/3	S/4	S/5	
	Mod. 155 con oreja	400	425	450	475	504	532	
	Mod. 175 con oreja	400	425	450	475	504	532	
	Mod. 195 con oreja	410	435	460	490	519	549	
L	Mod. 215 con oreja *Incluye 2 riñoneras (2 respaldos)	425	450	475	505	535	566	
	SOFAS 1 BR. + OREJA	S/0	S/1	S/2	S/3	S/4	S/5	
	Sofá 178 (1 Br. + oreja)	440	460	485	515	546	577	
	Sofá 198 (1 Br. + oreja)	440	460	485	515	546	577	
M	Sofá 218 (1 Br. + oreja)	460	480	505	535	567	599	
	Sofá 238 (1 Br. + oreja) *Incluye 1 cuadrante + 2 riñoneras (2 respaldos)	490	520	550	590	625	661	
	EXTRAS	S/0	S/1	S/2	S/3	S/4	S/5	
	Cuadrante 45x45	10	13	16	20	24	28	
Riñonera 55x35	9	12	15	19	23	27		
Cubre Brazo	12	14	16	20	24	28		
Metraje	12	15	19	22	25	28		
N	COMPOSICIONES	S/0	S/1	S/2	S/3	S/4	S/5	
	Comp. 286x180 Mod. 183 (D) + Terminal 103x180 (E)	735	785	835	895	949	1002	
	Comp. 316x180 Mod. 203 (D) + Terminal 113x180 (E)	765	815	865	925	981	1036	
	Comp. 286x215 Mod. 183 (D) + Terminal 103x215 (F)	785	835	885	945	1002	1058	
O	Comp. 316x215 Mod. 203 (D) + Terminal 113x215 (F)	815	865	915	975	1034	1092	

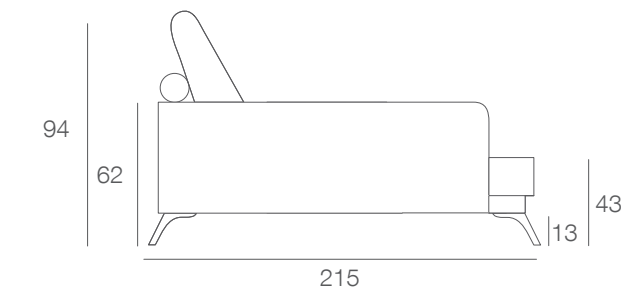
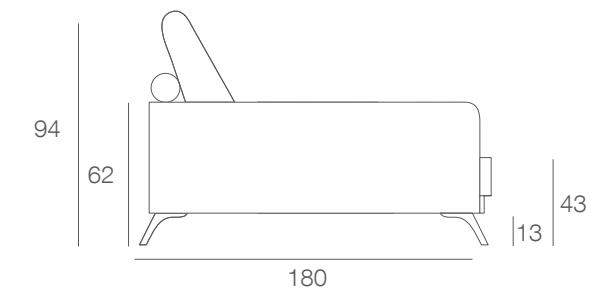
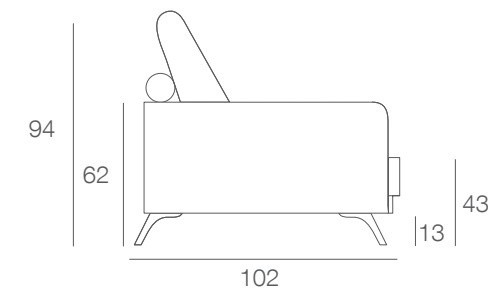

*Tarifa de precio en puntos

MODELO

Ons



DESAFÍA A LA GRAVEDAD

EXTRAÍBLE DE CARRO

TARIFA POR PUNTOS

MÓDULOS	S/0	S/1	S/2	S/3	S/4	S/5	T/CL	Mts.
Mod.1Pl. 66cm. S/Br.(As66)	245	254	265	276	292	310	232	3,4
Mod.1Pl. 80cm. S/Br. (As80)	267	276	290	304	323	346	250	4,1
Mod.1Pl. 86cm. S/Br. (As86)	286	294	306	320	338	360	268	4,2
Mod.1Pl. 96cm. S/Br. (As96)	296	306	320	335	354	377	278	4,3
Mod.1Pl. 106cm.S/Br. (As106)	312	323	338	354	375	398	294	4,6
Mod.1Pl. 116 cm.S/Br.(As116)	331	342	358	375	396	422	312	5
MÓDULOS	S/0	S/1	S/2	S/3	S/4	S/5	T/CL	Mts.
Mod.1Pl. 91cm. C/Br.(As66)	296	309	325	343	364	385	282	5,8
Mod.1Pl. 105cm. C/Br. (As80)	315	331	348	366	388	411	298	6,3
Mod.1Pl. 111cm. C/Br. (As86)	331	345	364	384	408	431	316	6,5
Mod.1Pl. 121cm. C/Br. (As96)	343	359	379	400	425	449	327	6,7
Mod.1Pl. 131cm.C/Br. (As106)	363	379	399	422	448	474	344	7
Mod.1Pl. 141 cm.C/Br.(As116)	378	394	416	439	467	494	358	7,3
MÓDULOS	S/0	S/1	S/2	S/3	S/4	S/5	T/CL	Mts.
Mod.2Pl. 132 cm. S/Br. (2As.66cm)	412	428	450	477	508	538	379	6,8
Mod. 2 Pl. 160 cm. S/Br. (2As.80cm)	452	469	495	525	560	595	414	7,6
Mod. 2 Pl. 172 cm. S/Br. (2As.86cm)	480	498	525	557	594	632	445	8,1
MÓDULOS	S/0	S/1	S/2	S/3	S/4	S/5	T/CL	Mts.
Mod. 2 Pl. 157 cm. C/Br. (2As.66cm)	455	472	496	526	559	593	422	8,7
Mod. 2 Pl. 185 cm. C/Br. (2As.80cm)	493	512	540	572	610	648	455	9,6
Mod. 2 Pl. 197 cm. C/Br. (2As.86cm)	525	546	576	610	650	702	485	10,2
CHAISELONGUE	S/0	S/1	S/2	S/3	S/4	S/5	T/CL	Mts.
Chaiselongue 95 x 170 (1Asiento.70cm)	373	389	405	431	457	484	352	6,3
Chaiselongue 105 x 170 (1Asiento.80cm)	388	405	422	450	478	507	372	6,6
Chaiselongue 115 x 170 (1Asiento.90cm)	413	429	447	477	507	537	392	7,1
EXTRAS	S/0	S/1	S/2	S/3	S/4	S/5	T/CL	Mts.
Cuadrantes 45x45	10	13	16	20	24	28	7	0.60u.
Riñoneras 55x35	9	12	15	19	23	27	6	0.50u.
Metraje	12	15	19	22	26	30		

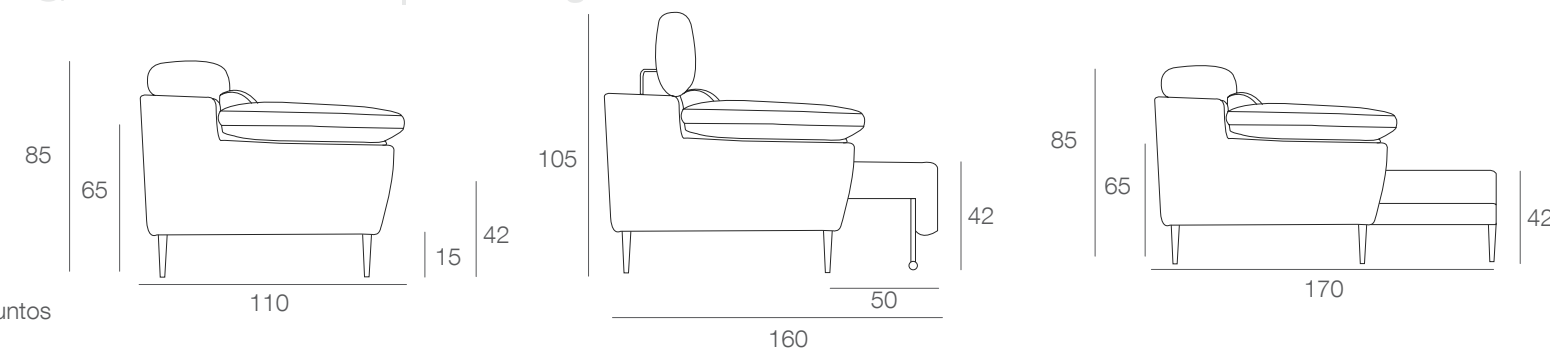
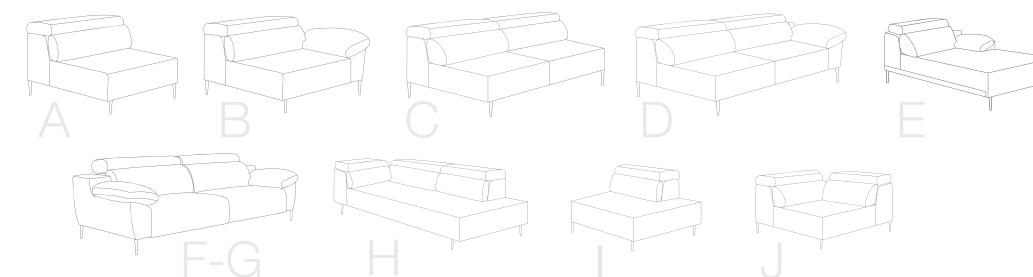

*Tarifa de precio en puntos

SOFÁS 2 BR.(1pieza)	S/0	S/1	S/2	S/3	S/4	S/5	T/CL	Mts.
Sofá 182 (2 as. 66)	520	543	572	606	646	694	490	10,5
Sofá 210 (2 as. 80)	560	585	617	655	699	745	526	11,4
Sofá 222 (2 as. 86)	605	632	665	706	752	800	570	12,2
SOFÁS 2 BR.(partidos)	S/0	S/1	S/2	S/3	S/4	S/5	T/CL	Mts.
Sofá 182 (2 as. 66)	592	618	650	686	728	770	564	11,6
Sofá 210 (2 as. 80)	630	662	696	732	776	822	596	12,6
Sofá 222 (2 as. 86)	662	690	728	768	816	862	632	13
Sofá 242 (2 as. 96)	686	718	758	800	850	898	654	13,4
Sofá 262 (2 as. 106)	726	758	798	844	896	948	688	14
Sofá 282 (2 as. 116)	756	788	832	878	934	988	716	14,6
TERMINAL RINCÓN	S/0	S/1	S/2	S/3	S/4	S/5	T/CL	Mts.
Chaise terminal 100x200	495	515	540	578	630	672	455	9
Chaise terminal 110x200	510	530	555	601	646	692	470	9,5
TERMINAL ABIERTO	S/0	S/1	S/2	S/3	S/4	S/5	T/CL	Mts.
Terminal abierto 105 (1respaldo 70cm)	341	355	371	400	428	456	310	6
Terminal abierto 115 (1respaldo 80cm)	350	365	382	414	444	475	320	6,5
Terminal abierto 125 (1respaldo 90cm)	362	378	397	430	463	496	330	7
RINCÓN	S/0	S/1	S/2	S/3	S/4	S/5	T/CL	Mts.
Rincón 110x110	375	391	412	447	483	518	338	7,5
POUFF (CAJÓN TAPIZADO)	S/0	S/1	S/2	S/3	S/4	S/5	T/CL	Mts.
Pouff 80 x 80	155	165	175	188	199	210	145	3
Pouff 90 x 60	165	175	185	198	209	221	155	3,5
COMPOSICIONES	S/0	S/1	S/2	S/3	S/4	S/5	T/CL	Mts.
Comp. Sofá 3 asientos 248 cm. (mod. 157 c/b + mod. 91 c/b)	751	781	821	869	923	978	704	14,5
Comp. Sofá 3 asientos 290 cm. (mod. 185 c/b + mod. 105 c/b)	808	843	888	938	998	1059	753	15,9
Comp. Sofá 3 asientos 308 cm. (mod. 197 c/b + mod. 111 c/b)	856	891	940	994	1058	1133	801	16,7
Comp. chaiselongue 290 X 170 cm. (mod. 185 c/b + chaise 105 c/b)	881	917	962	1022	1088	1155	827	16,2
Comp. chaiselongue 312 X 170 cm. (mod. 197 c/b + chaise 115 c/b)	938	975	1023	1087	1157	1239	877	17,3
Comp. Term. Rincón 295 X 200 cm. (mod. 185 c/b + terminal rincón 110 c/b)	1003	1042	1095	1173	1256	1340	925	19,1
Comp. Term. Rincón 307 X 200 cm. (mod. 197 c/b + terminal rincón 110)	1035	1076	1131	1211	1296	1384	1394	19,7
Comp. Rincón + Terminal abierto 295 X 225 cm. (mod. 185 c/b + rincón 110x110 + terminal abierto 115cm)	1218	1268	1334	1433	1537	1641	1113	23,6
Comp. Rincón + Terminal abierto 307 X 236 cm. (mod. 197 c/b + rincón 110x110 + terminal abierto 125cm)	1262	1315	1385	1487	1596	1716	1153	24,7

Fondo asiento
55 cerrado /105 abierto

Nilo

PARA LOS MÁS SOÑADORES



Combinación 1

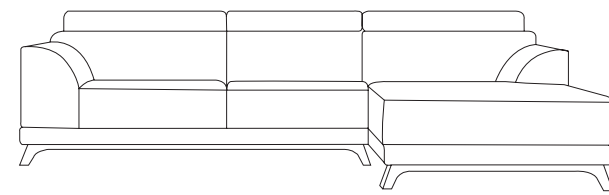

Mod 2 PL C/B (C) + Chaiselongue (D)

Combinación 2

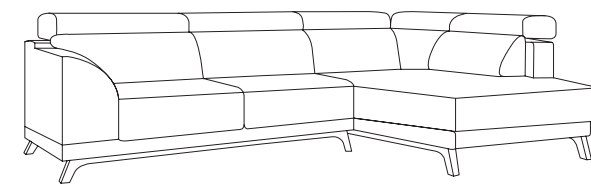

Mod 2 PL C/B (C) + Terminal Rincón (E)

Combinación 3

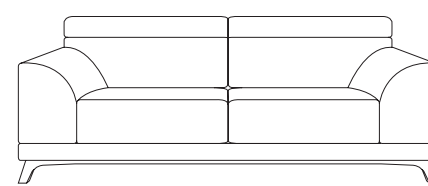

Sofá 2 Asientos (H)

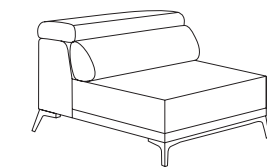

A Mod. 1PL S/B

| 60 | 70 | 80 | 90 |

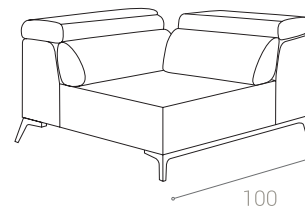

F Mod. Rincón

| 100 |

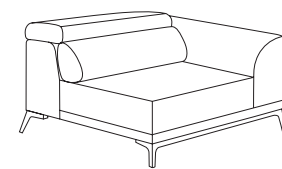

B Mod. 1PL C/B

| 90 | 100 | 110 | 120 |

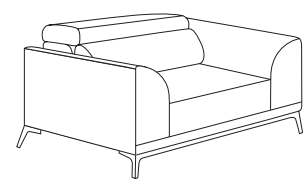

G Sillón

| 120 |

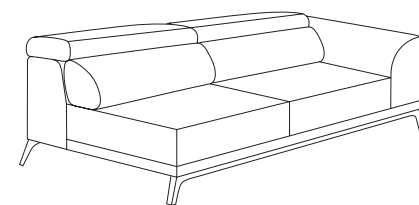

C Mod. 2PL C/B

| 150 | 170 | 290 | 210 |

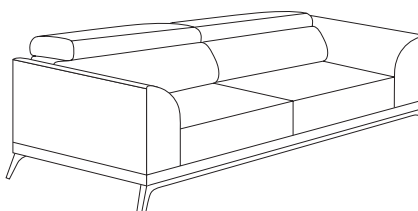

H Sofás (2 Asientos)

| 180 | 200 | 220 | 240 |

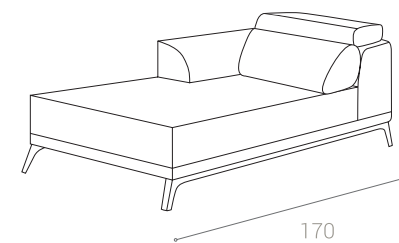

D Chaiselonge C/B

| 100 | 110 |

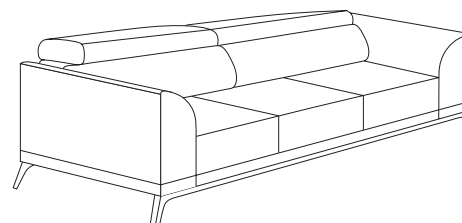

I Sofás (3 Asientos)

| 240 |

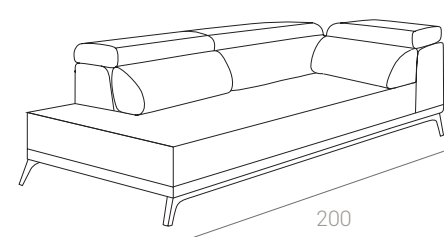

E Terminal Rincón

| 100 | 110 |

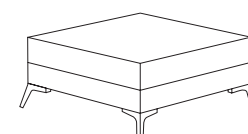

J Pouff

| 70 x 70 | 80 x 80 |

- Se puede fabricar a medida sobre presupuesto

TARIFA POR PUNTOS

Módulos

	S/0	S/1	S/2	S/3
A MOD. 1 PL.- 60 cm. S/ BRAZO	220	225	240	265
MOD. 1 PL.- 70 cm. S/ BRAZO	225	235	250	275
MOD. 1 PL.- 80 cm. S/ BRAZO	235	245	260	285
MOD. 1 PL.- 90 cm. S/ BRAZO	245	255	270	295
B MOD. 1 PL.- 90 cm. C/ BRAZO	270	280	295	315
MOD. 1 PL.- 100 cm. C/ BRAZO	280	290	305	325
MOD. 1 PL.- 110 cm. C/ BRAZO	290	300	315	335
MOD. 1 PL.- 120 cm. C/ BRAZO	300	310	325	345
C MOD. 2PL.- 150 cm. C/ BRAZO	415	430	450	485
MOD. 2 PL.- 170 cm. C/ BRAZO	430	445	465	500
MOD. 2PL.- 190 cm. C/ BRAZO	440	455	475	510
MOD. 2PL.- 210 cm. C/ BRAZO	460	475	495	530
D CHAISSELONGUE L - 100 cm. C/ BRAZO	330	345	365	395
CHAISSELONGUE L - 110 cm. C/ BRAZO	335	350	370	400
E TERMINAL RINCÓN - 100 x 200 cm.	460	480	510	560
TERMINAL RINCÓN 110 x 200 cm.	470	490	520	570
F RINCÓN 100 X 100 (2 CABEZALES 70 cm.)	360	380	410	455
J POUFF 70 X 70	140	150	165	190
POUFF 80 X 80	150	160	175	200
Sofás				
G SILLÓN - 120 (1 ASIENTO DE 60)	350	365	385	415
H SOFA 2 PL.- 180 (2 ASIENTOS DE 60 cm.)	475	495	525	570
SOFA 3 PL.- 200 (2 ASIENTOS DE 70 cm.)	490	510	540	585
SOFA 3,5 PL.- 220 (2 ASIENTOS DE 80 cm.)	500	520	550	595
I SOFA 4 PL.- 240 (2 ASIENTOS DE 90 cm.)	540	560	595	650
SOFA 4 PL.- 240 (3 ASIENTOS DE 60 cm.)	635	660	695	750

Medidas

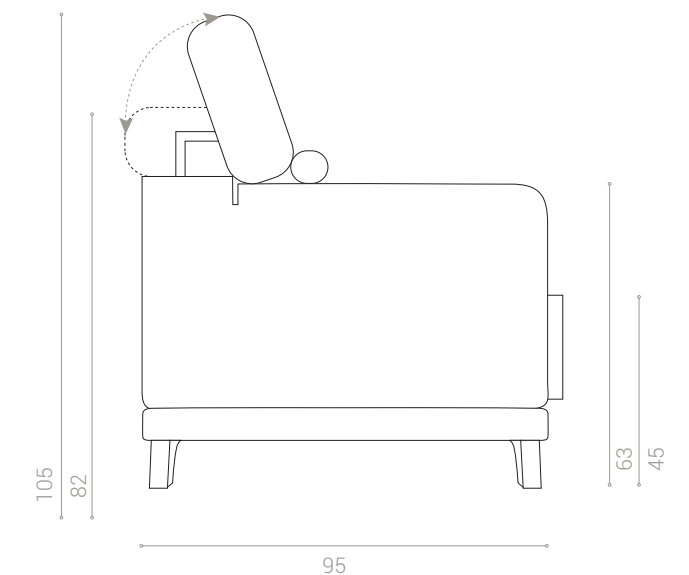

Composiciones

	S/0	S/1	S/2	S/3
COMP. 270 cm.				
MOD. 170 + CHAISSELONGUE 100 (ASIENTOS DE 70 cm.)	760	790	830	895
COMP. 300 cm.				
MOD. 190 + CHAISSELONGUE 110 (ASIENTOS DE 80 cm.)	775	805	845	910
COMP. TERMINAL RINCÓN 300 cm.	910	945	995	1080
MOD. 190 + TERMINAL RINCÓN 110 (ASIENTOS DE 80 cm.)				

Extras

	S/0	S/1	S/2	S/3
CUBREBRAZOS (UD.)	12	14	16	20
CUADRANTE (UD.)	10	13	16	20
RIÑONERA (UD.)	9	12	15	19

*Incluye 2 Cojines por composición o sofá, o 1 por brazo.

*Todos los sofás de 240 se servirán con brazos desmontables de serie (se verá el zócalo partido). En el resto de medidas se fabricarán en una pieza salvo petición del cliente.



TARIFA POR PUNTOS

A

MÓDULOS	S/0	S/1	S/2	S/3	S/4	S/5	T/C	Mts.
Mod 1 Pl. 67 cm. S/ Br.	180	195	205	220	235	250	160	3,50
Mod 1 Pl. 82 cm. S/ Br.	195	205	220	235	250	265	170	4,00
Mod 1 Pl. 97 cm. S/Br.	215	240	255	270	285	300	200	4,50
Mod 1 Pl. 112 cm. S/Br.	245	265	280	295	310	325	220	5,00

B

MÓDULOS	S/0	S/1	S/2	S/3	S/4	S/5	T/C	Mts.
Mod 1 Pl. 82 cm. C/ Br.	215	230	240	255	270	285	195	4,50
Mod 1 Pl. 97 cm. C/ Br.	230	240	255	270	285	300	205	5,00
Mod 1 Pl. 112 cm. C/Br.	250	275	290	305	320	335	235	5,50
Mod 1 Pl. 127 cm. C/Br.	280	300	315	330	345	360	255	6,00

C

MÓDULOS	S/0	S/1	S/2	S/3	S/4	S/5	T/C	Mts.
Mod 2 Pl. 135 cm. S/ Br.	320	345	365	395	430	450	290	6,0
Mod 2 Pl. 165 cm. S/ Br.	350	380	405	445	485	520	320	9,0

D

MÓDULOS	S/0	S/1	S/2	S/3	S/4	S/5	T/C	Mts.
Mod 2 Pl. 150 cm. C/ Br.	355	380	400	430	465	485	325	7,00
Mod 2 Pl. 180 cm. C/ Br.	385	415	440	480	520	555	355	10,00

E

CHAISELONGUE	S/0	S/1	S/2	S/3	S/4	S/5	T/C	Mts.
Chaiselongue 82cm C/Br	340	360	380	405	425	450	300	7
Chaiselongue 97cm C/Br	360	380	400	425	445	470	320	7,5
Chaiselongue 112cm C/Br	380	400	420	445	465	490	340	8
Chaiselongue 127cm C/Br	400	420	440	465	485	505	360	8,5

MEDIDAS

Fondo exterior	85
Fondo asiento	54
Altura respaldo	96
Altura asiento	44
Altura brazo	64
Ancho brazo	15
Altura patas	12,5
Largo chais	165

*Tarifa de precio en puntos

F

POUFFS	S/0	S/1	S/2	S/3	S/4	S/5	T/C	Mts.
Pouff 67x67	140	150	160	170	180	190	130	2,80
Pouff 82x82	155	165	175	185	195	205	145	3,20
Pouff 97x97	170	180	190	200	210	220	160	3,80

G

SOFÁS	S/0	S/1	S/2	S/3	S/4	S/5	T/C	Mts.
Sofá 165. 1pieza (2 asientos 67)	395	420	440	470	505	525	360	8,00
Sofá 195. 1pieza (2 asientos 82)	425	455	480	520	560	595	395	11,00
Sofá 225. 2 piezas (2 asientos 97)	500	550	580	610	640	670	470	11,50
Sofá 255. 2piezas (2 asientos 112)	560	600	630	660	690	720	510	12,00

H

SILLÓN	S/0	S/1	S/2	S/3	S/4	S/5	T/C	Mts.
Sillón 90cm (asiento 60)	280	300	320	340	360	380	250	5,50
Sillón 90cm (asiento 60) Pie giratorio	345	365	385	405	425	445	315	5,50

I

COMPOSICIONES	S/0	S/1	S/2	S/3	S/4	S/5	T/C	Mts.
Comp. Chaislongue 277 cm. (mod. 180 c/b + chais 97) asientos 82 cm.	745	795	840	905	965	1025	675	17,5
Comp. 3+2 (sofá 165 + sofá 195 cm)	820	875	920	990	1065	1120	755	19

J

EXTRAS	S/0	S/1	S/2	S/3	S/4	S/5	T/C	Mts.
Cuadrante (45x45)	10	13	16	20	24	28	7	0,60/u
Riñonera (55x35)	9	12	15	19	23	27	6	0,50/u
Cuadrante especial (45x45)	14	17	20	23	28	31	10	0,60/u
Respaldo extra 60cm	34	36	39	42	46	50	28	1,20/u
Cabezerilla	24	26	28	30	32	34	21	1,00/u
Metraje	12	15	19	22	26	30	6	

*Tdas las piezas incluyen un cuadrante especial por brazo

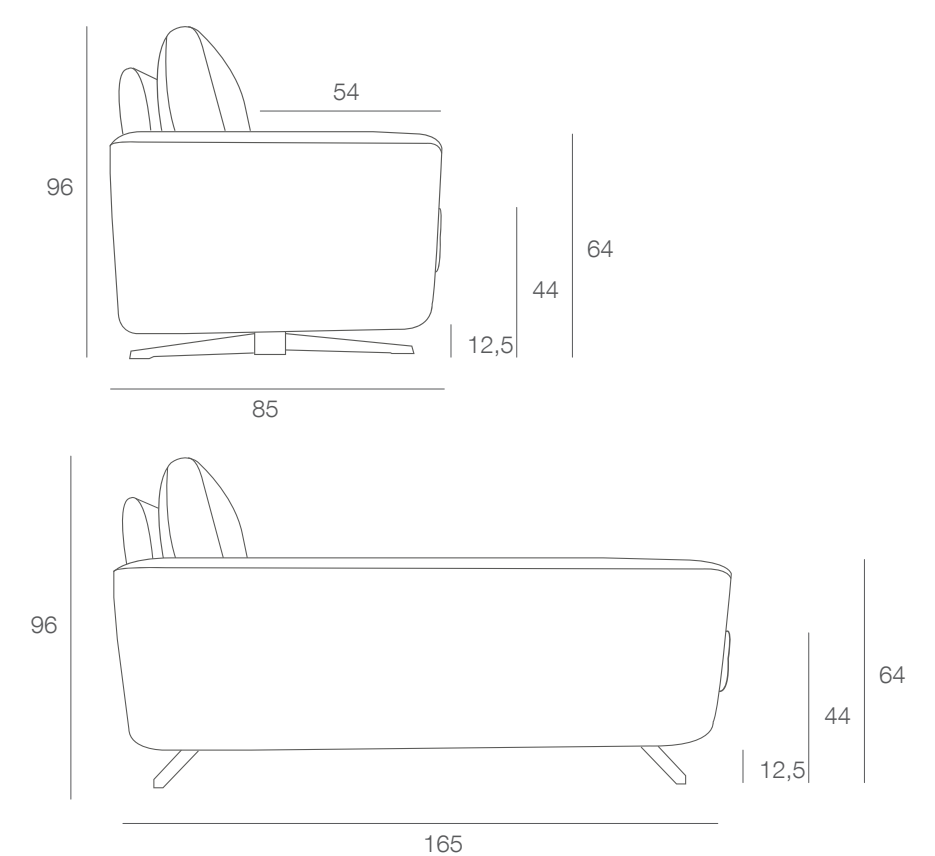

OPCIÓN
PIE GIRATORIO

MODELO Dali

ESPACIOS CON FRESCURA

SENTADA EN MUELLE ENSACADO





MODELO

Loira

ELEGANCIA EN CADA PESPUNTE

ELEMENTOS Y COMBINACIONES

COMBINACIÓN 1

Mod 2 Pl (C) + Mod 1 Pl (B)

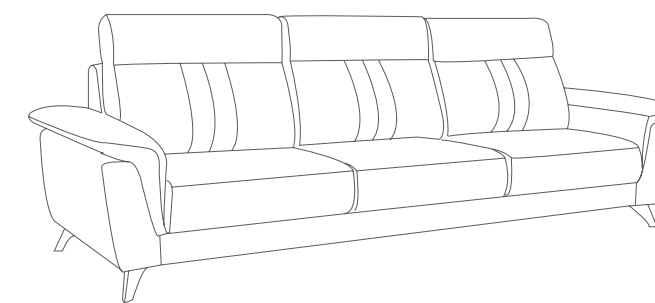

COMBINACIÓN 2

Mod 2 Pl (C) + Chaiselongue (D)

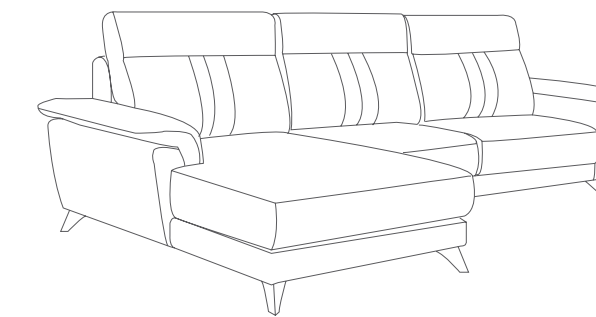

COMBINACIÓN 3

Sofá 2 asientos (E)

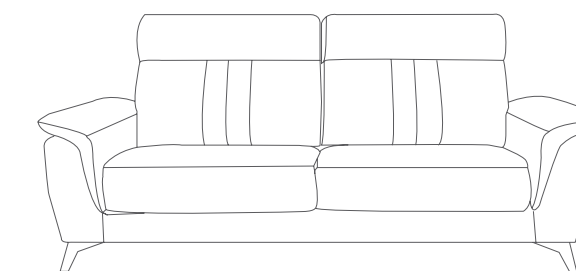

TARIFA POR PUNTOS

A	MÓDULOS	S/0	S/1	S/2	S/3	S/4	S/5	T/CL	Mts.
	Mod. 1 Pl. 60 cm. S/Br.	195	205	215	235	250	270	175	4.00
	Mod. 1 Pl. 70 cm. S/Br.	205	215	230	250	270	290	190	4.50
	Mod. 1 Pl. 80 cm. S/Br.	220	230	245	265	285	310	200	5.00
	Mod. 1 Pl. 90 cm. S/Br.	240	250	265	285	310	330	210	5.50

B	MÓDULOS	S/0	S/1	S/2	S/3	S/4	S/5	T/CL	Mts.
	Mod. 1 Pl. 85 cm. C/Br.	230	245	260	280	300	320	210	4.70
	Mod. 1 Pl. 95 cm. C/Br.	245	255	270	290	315	335	220	5.00
	Mod. 1 Pl. 105 cm. C/Br.	255	270	285	305	330	350	230	5.40
	Mod. 1 Pl. 115 cm. C/Br.	270	285	300	320	350	375	245	5.70

C	MÓDULOS	S/0	S/1	S/2	S/3	S/4	S/5	T/CL	Mts.
	Mod. 2 Pl. 145 cm. C/Br.	360	380	405	430	455	480	330	7.50
	Mod. 2 Pl. 165 cm. C/Br.	380	400	425	455	480	505	350	8.00
	Mod. 2 Pl. 185 cm. C/Br.	410	430	460	490	515	540	380	8.60
	Mod. 2 Pl. 205 cm. C/Br.	435	460	490	520	545	570	405	9.20

D	CHAISELONGUE	S/0	S/1	S/2	S/3	S/4	S/5	T/CL	Mts.
	Chaiselongue 95 x 165	300	320	340	370	395	425	275	6.50
	Chaiselongue 105 x 165	325	345	365	395	420	450	300	7.00

E	SOFÁS	S/0	S/1	S/2	S/3	S/4	S/5	T/CL	Mts.
	Sofá 170 (2 as. 60)	400	425	455	485	515	550	360	8.80
	Sofá 190 (2 as. 70)	430	455	485	520	555	590	390	9.20
	Sofá 210 (2 as. 80)	450	475	505	545	580	615	410	10
	Sofá 230 (2 as. 90)	490	505	540	590	625	645	450	10.60
	Sofá 230 (3 as. 60)	570	605	640	680	720	760	530	13

F	POUFF	S/0	S/1	S/2	S/3	S/4	S/5	T/CL	Mts.
	Pouff 60 x 60	135	145	155	165	175	185	125	2.80
	Pouff 70 x 70	135	145	155	165	175	185	125	2.80
	Pouff 80 x 80	145	155	165	175	185	195	135	2.80
	Pouff 90 x 90	160	170	180	190	200	210	150	3.20

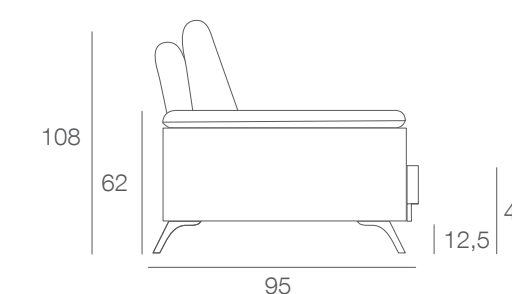

Fondo asiento 55/90

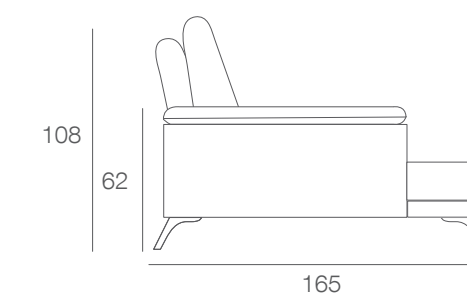

COMPOSICIONES	S/0	S/1	S/2	S/3	S/4	S/5	T/CL	Mts.
Comp. 260 (Chaise as.70)	680	720	765	825	875	930	625	14.50
Comp. 290 (Chaise as.80)	735	775	825	885	935	990	680	15.60
Comp. Sofá 260 + Pouff as. 70	760	800	850	910	970	1025	695	15.80
Comp. Sofá 290 + Pouff as. 80	810	855	910	970	1030	1085	745	16.80

EXTRAS	S/0	S/1	S/2	S/3	S/4	S/5	T/CL	Mts.
Cuadrantes	10	13	16	20	24	28	7	0.60/u
Riñoneras	9	12	15	19	23	27	6	0.50/u
Metraje	12	15	19	22	26	30		

*Tarifa de precio en puntos

MODELO

New Califa

ELEGANCIA Y COMODIDAD



TARIFA POR PUNTOS

MÓDULOS	S/0	S/1	S/2	S/3	S/4	S/5	T/C	Mts.
Mod 60. 1 Pl. 60 cm. S/ Br.	220	230	245	265	285	300	205	4.00
Mod 70. 1 Pl. 70 cm. S/ Br.	225	235	250	275	295	310	210	4.50
Mod 80. 1 Pl. 80 cm. S/Br.	235	245	260	285	305	325	220	5.00
Mod 90. 1 Pl. 90 cm. S/Br.	245	255	270	295	315	335	230	5.50



MÓDULOS	S/0	S/1	S/2	S/3	S/4	S/5	T/C	Mts.
Mod 90. 1 Pl. 60 cm. C/ Br.	270	280	295	315	335	355	245	6.00
Mod 100. 1 Pl. 70 cm. C/ Br.	280	290	305	325	345	365	255	6.50
Mod 110. 1 Pl. 80 cm. C/Br.	290	300	315	335	355	375	265	7.00
Mod 120. 1 Pl. 90 cm. C/Br.	305	315	330	350	370	395	280	7.50



MÓDULOS	S/0	S/1	S/2	S/3	S/4	S/5	T/C	Mts.
Mod 120. 2 Pl. 60 cm. S/ Br.	370	385	405	440	465	495	335	8.00
Mod 140. 2 Pl. 70 cm. S/ Br.	385	400	420	455	485	510	350	8.50
Mod 160. 2 Pl. 80 cm. S/Br.	395	410	430	465	490	525	360	9.00
Mod 180. 2 Pl. 90 cm. S/Br.	415	430	450	485	515	545	380	9.50

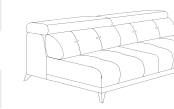

MÓDULOS	S/0	S/1	S/2	S/3	S/4	S/5	T/C	Mts.
Mod 150. 2 Pl. 60 cm. C/ Br.	415	430	450	485	515	545	385	9.00
Mod 170. 2 Pl. 70 cm. C/ Br.	430	445	465	500	530	560	400	9.50
Mod 190. 2 Pl. 80 cm. C/Br.	445	460	480	515	545	580	415	10.0
Mod 210. 2 Pl. 90 cm. C/Br.	465	480	500	545	575	610	435	10.50



CHAISELONGUE	S/0	S/1	S/2	S/3	S/4	S/5	T/C	Mts.
Chaiselongue "L" 100cm C/Br	330	345	365	395	420	445	305	7.00
Chaiselongue "L" 110cm C/Br	345	360	380	410	435	460	320	7.50



TERMINAL RINCÓN	S/0	S/1	S/2	S/3	S/4	S/5	T/C	Mts.
Terminal rincón 100x200	470	490	520	570	605	640	440	8.50
Terminal rincón 110x200	485	505	535	585	620	660	455	9.00



TERMINAL ABIERTO	S/0	S/1	S/2	S/3	S/4	S/5	T/C	Mts.
Terminal abierto 105	320	340	360	390	415	445	290	6.50
Terminal abierto 115	330	350	370	400	425	455	300	7.00



RINCONERAS 100X100	S/0	S/1	S/2	S/3	S/4	S/5	T/C	Mts.
Rincón redondo sin cabezales	310	330	350	380	405	430	285	6.00
Rincón cuadrado cabezales abatibles	360	380	410	455	480	510	330	8.00

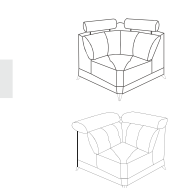

POUFFS	S/0	S/1	S/2	S/3	S/4	S/5	T/C	Mts.
Pouff 70x70	140	150	165	190	205	220	130	3.00
Pouff 80x80	150	160	175	200	215	230	140	3.50
Pouff 90x90	165	180	195	215	230	250	155	4.00



SOFÁS	S/0	S/1	S/2	S/3	S/4	S/5	T/C	Mts.
Sofá 2pl. 180 (2 asientos 60)	475	495	525	570	605	640	430	11.0
Sofá 3pl. 200 (2 asientos 70)	490	510	540	585	620	660	445	11.5

Sofá 3,5pl. 220 (2 asientos 80)	510	530	560	605	640	680	465	12.0
Sofá 4pl. 240 (2 asientos 90)	550	570	605	660	700	745	505	12.5

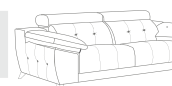

Sofá 4pl. 240 (3 asientos 60)	645	670	705	760	805	855	585	13.0
Sillón 120 (asiento 60)	350	365	385	415	440	470	320	7.5

*Los sofás de más de 205cm se sirven con brazos desmontables

COMPOSICIONES	S/0	S/1	S/2	S/3	S/4	S/5	T/C	Mts.
Comp. chaise 270cm. Mod.170 + chaise 100 (asientos 70)	760	790	830	895	950	1005	705	16.5

Comp. chaise 300cm. Mod.190 + chaise 110 (asientos 80)	790	820	860	925	980	1040	735	17.5
--	-----	-----	-----	-----	-----	------	-----	------

Comp. Terminal rincón 300cm. Mod.190 + terminal rincón 110 (asientos 80)	930	965	1015	1100	1165	1240	870	19.0
--	-----	-----	------	------	------	------	-----	------

EXTRAS	S/0	S/1	S/2	S/3	S/4	S/5	T/C	Mts.
Cuadrante (unidad)	10	13	16	20	24	28	7	0.60/u
Riñonera (unidad)	9	12	15	19	23	27	6	0.50/u
Metraje	12	15	19	22	26	30		

Cristales 4€/und

*MEDIDAS DE CATALOGO CON BRAZO ESTANDAR DE 30 CM, POSIBILIDAD DE REDUCCION A 25 Y 20 CM.

MEDIDAS	
Fondo exterior	95
Salida extraíble	35
Fondo asiento	48/90
Altura	80/103
Altura asiento	44
Altura brazo	60
Ancho brazo	30
Altura patas	12,5
Largo chais	170

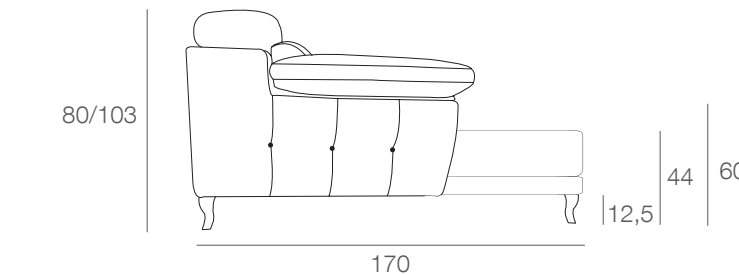
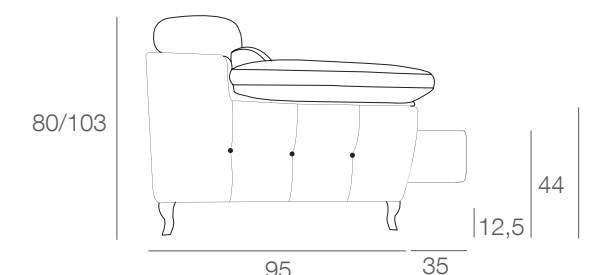
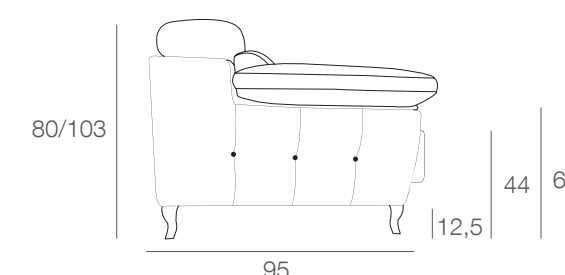







*Tarifa de precio en puntos



Betty

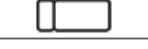

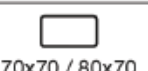
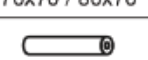
TARIFA POR PUNTOS

MÓDULOS	ARTÍCULO	SERIE 0	SERIE 1	SERIE 2	SERIE 3	T/ CLIENTE	METRAJE
 60/70/80/90	MOD.- 60 cm. S/ BRAZO (1 asiento 60)	200	215	233	255	190	4,00
	MOD.- 70 cm. S/ BRAZO (1 asiento 70)	213	228	246	265	201	4,50
	MOD.- 80 cm. S/ BRAZO (1 asiento 80)	221	238	258	280	213	5,00
	MOD.- 90 cm. S/ BRAZO (1 asiento 90)	235	255	278	300	228	5,50
 80/90/100/110	MOD.- 80 cm. C/ BRAZO (1asiento 60)	240	260	283	310	220	6,00
	MOD.- 90 cm. C/ BRAZO (1asiento 70)	251	272	299	327	230	6,50
	MOD.- 100 cm. C/ BRAZO (1 asiento 80)	260	282	308	340	238	7,00
	MOD.- 110 cm. C/ BRAZO (1 asiento 90)	280	302	332	360	258	7,50
 140/160/180/200	MOD.- 140 cm. C/ BRAZO (2 asientos 60)	385	415	443	485	330	9,00
	MOD.- 160 cm. C/ BRAZO (2 asientos 70)	395	425	458	500	340	9,50
	MOD.- 180 cm. C/ BRAZO (2 asientos 80)	405	435	473	515	350	10,00
	MOD.- 200 cm. C/ BRAZO (2 asientos 90)	420	450	488	530	365	11,00
	CHAISELONGUE"L" 90 cm. C/BR. (asiento de 70)	305	325	355	390	270	6,50
	CHAISELONGUE"L" 100 cm. C/BR. (asiento de 80)	310	330	360	395	275	7,00
	TERMINAL S/B RECLINABLE 60 cm.	177	192	206	224	151	3,50
	RINCÓN 100 x 100 cm. (redondo sin cabezales)	270	285	300	320	240	6,00
	RINCÓN 100 x 100 cm. (cuadrado con cabezales)	322	347	373	405	295	8,00
	TERMINAL CHAISELONGUE con cabezales	380	400	430	465	335	9,50
 70x70 / 80x70	POUFF 70 x 70 cm.	136	146	157	167	123	3,00
	POUFF 80 x 70 cm.	147	159	171	182	137	3,50
	METRAJE (mt.)	12	15	19	22		

SOFÁS

 160/180/200/220	SOFA 2PL 160 (2 asientos 60)	410	440	470	520	370	10,00
	SOFA 2PL 180 (2 asientos 70)	430	460	490	540	390	10,50
	SOFA 3PL 200 (2 asientos 80)	450	480	510	555	410	11,00
	SOFA 3PL 220 (2 asientos 90)	470	500	530	560	430	11,50
 220	SOFA 3PL 220 (3 asientos 60)	495	530	565	605	460	12,00

** TODOS LOS SOFÁS A PARTIR DE 2,05 SE SIRVEN CON BRAZOS DESMONTABLES

COMPOSICIONES

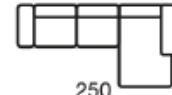
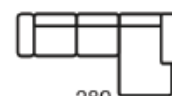
 250	COMPOSICIÓN 250 cm. CHAISELONGUE Mod.160 + Chaise 90 (asientos 70)	700	750	813	890	610	15,00
 280	COMPOSICIÓN 280 cm. CHAISELONGUE Mod.180 + Chaise 100 (asientos 80)	715	765	833	910	625	16,00

ESTRUCTURA: Madera maciza recubierta de espuma de poliuretano.

SUSPENSIÓN DEL ASIENTO: Bastidor deslizando punto a punto con ruedas nylon, suspensión de muelles de acero ondulado.

SUSPENSIÓN DEL RESPALDO: Cincha elastica 6 cm.

ALMOHADA DE ASIENTO: Espuma de poliuretano de 32 kg. Suave de alta calidad envuelta en fibra siliconada.

ALMOHADA DE RESPALDO: cabeceras con soportes metalicos cromados, sistema de carraca por posiciones espuma de poliuretano 25 kg. Super suave recubierto de fibra hueca.







ALMOHADA DE BRAZO: Espuma de poliuretano suave de 25kg. Recubierta de fibra siliconada.

PATAS: Madera barnizada color wengué ó natural 10,50 cm.

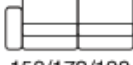

Tabarca
COMODIDAD ABSOLUTA

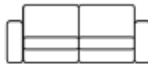
TARIFA POR PUNTOS

MÓDULOS	ARTÍCULO	SERIE 0	SERIE 1	SERIE 2	SERIE 3	T/ CLIENTE	METRAJE
 60/70/80	MOD. 1 PL.- 60 cm. S/ BRAZO	222	235	250	268	195	5,00
	MOD. 1 PL.- 70 cm. S/ BRAZO	237	251	267	287	208	5,50
	MOD. 1 PL.- 80 cm. S/ BRAZO	252	267	281	306	220	6,00
 90/100/110	MOD. 1 PL.- 90 cm. C/ BRAZO	262	282	304	328	232	7,00
	MOD. 1 PL.- 100 cm. C/ BRAZO	278	297	319	345	248	7,50
	MOD. 1 PL.- 110 cm. C/ BRAZO	292	312	334	362	255	8,00
 150/170/190	MOD. 2PL.- 150 cm. C/ BRAZO	393	421	448	480	345	9,50
	MOD. 2 PL.- 170 cm. C/ BRAZO	405	433	460	495	366	10,00
	MOD. 2PL.- 190 cm. C/ BRAZO	420	445	475	510	370	10,50
	TERMINAL ARCON 93	329	356	389	420	310	6,50
	TERMINAL ARCON 103	336	365	400	435	320	7,00
	METRAJE (mt.)	12	15	19	22		
SOFÁS							
 180/200/220	SOFA 180 (2 asientos 60)	431	466	502	545	390	11,00
	SOFA 200 (2 asientos 70)	452	488	527	570	410	11,50
	SOFA 220 (2 asientos 80)	474	510	552	595	435	12,00
 263	COMPOSICION 263cm. TERMINAL ARCON mod.170 + terminal 93 (asientos 70)	734	789	849	915	670	16,50
 293	COMPOSICIÓN 293 cm. CHAISE-LONGUE "L" mod.190+terminal 103 (asientos 80)	756	810	875	945	690	17,50

** Todos los sofás a partir de 2,05 se sirven con brazo desmontable,

** Todos los chaislonges seran con arcon de serie, incluyendo un cuadrante rectangular de 70*40 con telas de diseño a elegir.

ESTRUCTURA. Madera maciza y tablero de particulas recubierto de espuma de poliuretano.

SUSPENSION DEL ASIENTO. Bastidor deslizable punto a punto con ruedas nylon, suspension de muelles de acero ondulado.

SUSPENSION DEL RESPALDO. Cincha elastica 6 cm.

ALMOHADA DE ASIENTO. Espuma de poliuretano de 32 kg. + capa viscoelastica de alta calidad envuelta en fibra hueca siliconada.

ALMOHADAS DE RESPALDO. RIÑONERA. De fibra hueca siliconada de alta calidad. RESPALDO. Mecanismos reclinables metalicos. Espuma de poliuretano de 25kg. Super suave, envuelta en fibra hueca siliconada.

ALMOHADA BRAZO. Mecanismo reclinable arcon, con almohada de fibra hueca siliconada.

PATAS. Pies cromados de diseño de 5 cm.

OPCIONES ALMOHADAS:

HEXA



BEIG



MARRON



NEGRO

GALLO



BEIG



MARRON







NEGRO



Cloe

ESTILO Y VERSATILIDAD

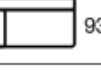

TARIFA POR PUNTOS

MÓDULOS	ARTÍCULO	SERIE 0	SERIE 1	SERIE 2	SERIE 3	T/ CLIENTE	METRAJE
 60/70/80/90	MOD.- 60 cm. S/ BRAZO (1 asiento 60)	222	235	250	268	195	5,00
	MOD.- 70 cm. S/ BRAZO (1 asiento 70)	237	251	267	287	208	5,50
	MOD.- 80 cm. S/ BRAZO (1 asiento 80)	252	267	281	306	220	6,00
	MOD.- 90 cm. S/ BRAZO (1 asiento 90)	272	289	302	333	236	6,50
 90/100/110/120	MOD.- 90 cm. C/ BRAZO (1asiento 60)	282	307	334	363	232	7,00
	MOD.- 100 cm. C/ BRAZO (1 asiento 70)	298	322	349	380	248	7,50
	MOD.- 110 cm. C/ BRAZO (1 asiento 80)	312	337	364	397	255	8,00
	MOD.- 120 cm. C/ BRAZO (1 asiento 90)	335	360	390	425	278	8,50
 150/170/190/210	MOD.- 150 cm. C/ BRAZO (2 asientos 60)	413	446	478	515	345	9,50
	MOD.- 170 cm. C/ BRAZO (2 asientos 70)	425	458	490	530	366	10,00
	MOD.- 190 cm. C/ BRAZO (2 asientos 80)	440	470	505	545	370	10,50
	MOD.- 210 cm. C/ BRAZO (2 asientos 90)	470	505	545	590	415	11,00
 93 / 103	TERMINAL ARCÓN 93	329	356	389	420	310	6,50
	TERMINAL ARCÓN 103	336	365	400	435	320	7,00
	METRAJE (mt.)	12	15	19	22		

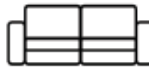
SOFÁS

 180/200/220/240	SOFA 2PL 180 (2 asientos 60)	456	496	537	585	390	11,00
	SOFA 3PL 200 (2 asientos 70)	477	518	562	610	410	11,50
	SOFA 3,5PL 220 (2 asientos 80)	499	540	587	635	435	12,00
	SOFA 4PL 240 (2 asientos 90)	539	585	635	690	474	13,00

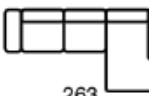
COMPOSICIONES

 263	COMPOSICIÓN 263 cm. TERMINAL ARCÓN Mod.170 + Terminal 93 (asientos 70)	754	814	879	950	670	16,50
 293	COMPOSICIÓN 293 cm. CHAISERLONGUE "L" Mod.190 + Terminal 103 (asientos 80)	776	835	905	980	690	17,50

* TODOS LOS SOFÁS A PARTIR DE 2,05 SE SIRVEN CON BRAZO DESMONTABLE.

* TODOS LOS CHAISERLONGUES SERÁN CON ARCÓN DE SERIE, INCLUYENDO UN CUADRANTE RECTANGULAR DE 70 X 40.

ESTRUCTURA: Madera maciza y tablero de partículas recubierto de espuma de poliuretano.

SUSPENSION DEL ASIENTO: Bastidor deslizante punto a punto con ruedas nylon, suspension de muelles de acero ondulado.

SUSPENSION DEL RESPALDO: Cincha elastica 6 cm.

ALMOHADA DE ASIENTO: Espuma de poliuretano de 32 kg. + capa viscoelastica de alta calidad envuelta en fibra hueca siliconada.

ALMOHADAS DE RESPALDO: RIÑONERA. De fibra hueca siliconada de alta calidad.

RESPALDO: Mecanismos reclinables metalicos. Espuma de poliuretano de 25kg. Super suave, envuelta en fibra hueca siliconada.



PATAS: Pies cromados de diseño de 5 cm.



Berlin

LO SENCILLO ES ELEGANTE

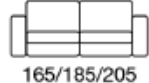
TARIFA POR PUNTOS

SOFAS	ARTÍCULO	SERIE 0	SERIE 1	SERIE 2	SERIE 3	T/ CLIENTE	METRAJE
 110	SILLON 110cm. (1 asiento 62)	312	336	360	384	272	8,00
 165/185/205	SOFÁ 165cm. (2 asientos 62)	422	454	486	518	361	10,50
	SOFÁ 185cm. (2 asientos 72)	439	471	503	535	378	11,00
	SOFÁ 205cm. (2 asientos 82)	456	488	520	552	395	11,50
 225	SOFÁ 225cm. (3 asientos 62)	504	539	574	609	441	12,00

*Todos los sofás a partir de 205cm. van con brazos desmontables.

*TODOS LOS SOFÁS INCLUYEN 2 CUADRANTES
*DESENFUNDABLES COMPLETAMENTE

ESTRUCTURA. Madera maciza y tablero de partículas recubierto de espuma de poliuretano
SUSPENSION DEL ASIENTO. Cincha NEA de 8 cm, de alta calidad
SUSPENSION DEL RESPALDO. Cincha elastica 6 cm.
ALMOHADA DE ASIENTO. Fibra de poliester hueca siliconada, con nucleo de espuma de poliuretano de 30 kg.
ALMOHADA DE RESPALDO. Fibra de poliester hueca siliconada.
CUADRANTES BRAZOS. Fibra de poliester hueca siliconada.
PATAS. De madera barnizada color wengue.

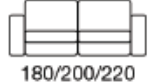

TARIFA POR PUNTOS

SOFAS	ARTÍCULO	SERIE 0	SERIE 1	SERIE 2	SERIE 3	T/ CLIENTE	METRAJE
 120	SILLÓN 120 cm. (a. 60)	262	284	305	325	227	8,00
 180/200/220	SOFÁ 2PL. 180 (2 asientos 60)	316	342	367	393	263	10,00
	SOFÁ 3PL. 200 (2 asientos 70)	332	360	387	414	278	10,50
	SOFÁ 3,5 PL 220 (2 asientos 80)	350	379	408	437	300	11,00

ESTRUCTURA. Madera maciza recubierta de espuma de poliuretano.
 SUSPENSION DEL ASIENTO. Cincha NEA de 8 cm, de alta calidad.
 SUSPENSION DEL RESPALDO. Cincha elastica de 6 cm.
 ALMOHADA DE ASIENTO. Espuma de poliuretano de 30kg, recubierta de fibra hueca siliconada.
 ALMOHADA DE RESPALDO. Fibra de poliester hueca siliconada.
 ALMOHADA DE BRAZO. Fibra de poliester hueca siliconada.
 PATAS. Pies de madera de 7 cm. Color wengue.



Capri

EL OASIS DEL CONFORT



CASTAÑOSOFÁS

www.castanosofas.es